



# Phoenix Leather Collection

LH2, RFC, FST corner group shown in Puglia Stone (Cover 1).

foamflex<sup>+</sup>

Colours represented are to be used as a guide only, colour shadings can vary slightly from each roll of fabric. Please refer to manufacturers swatch for more colour options.

03/02/2025

# PHOENIX LEATHER COVER GUIDE: STANDARD BACK

Please use this guide when ordering the following pieces to clarify cover options.

LH2, RFC, FST Corner Group  
LHF-S

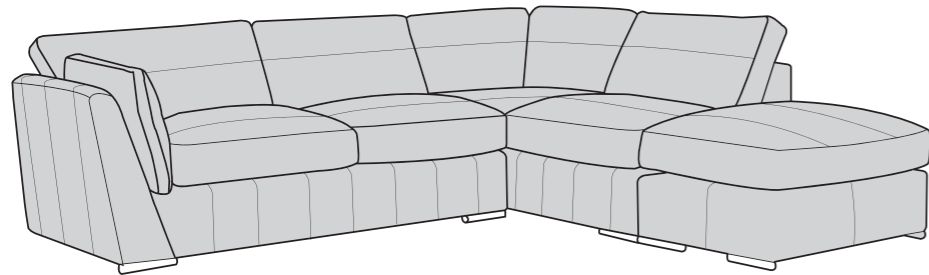

FST, LFC, RH2 Corner Group  
RHF-S

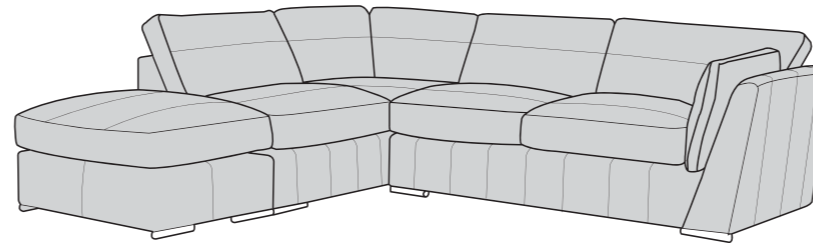

L2S, RFC, FST Corner Bed Group  
LHS-S

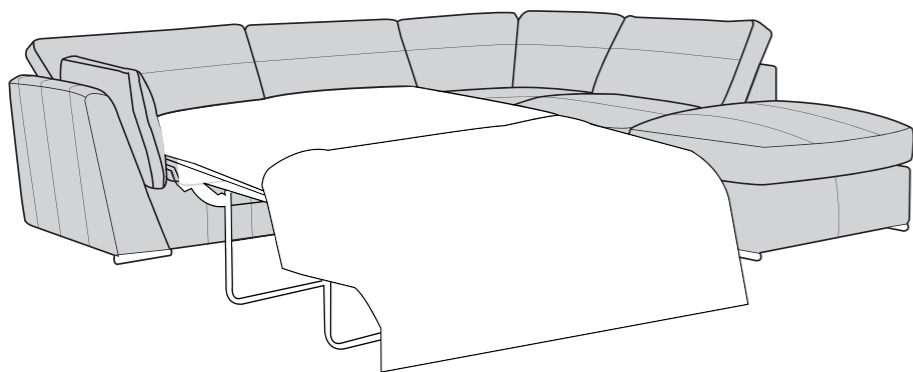

FST, LFC, R2S Corner Bed Group  
RHS-S

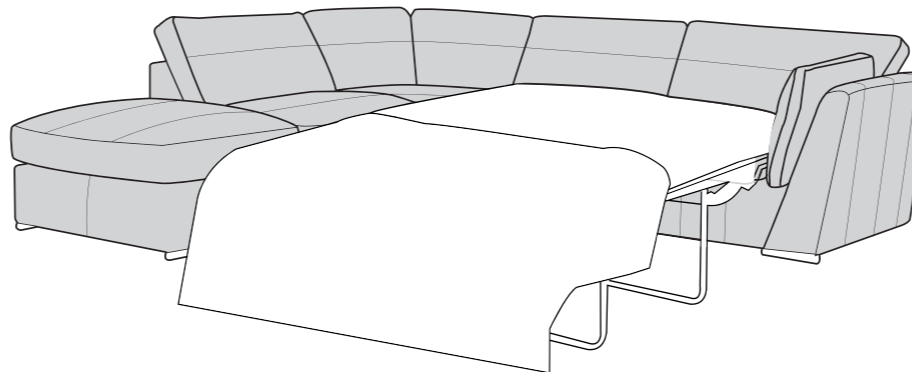

3 Seater Sofa - 3ST-S

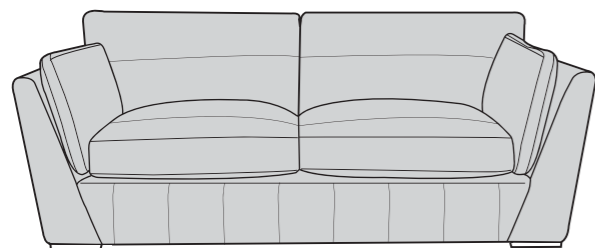

2 Seater Sofa - 2ST-S

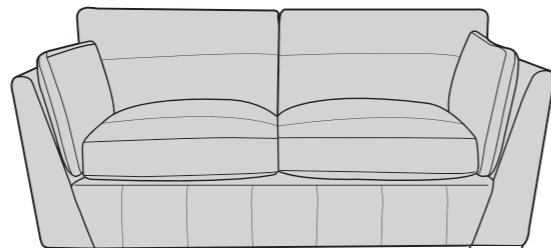

Love Chair LOV-S

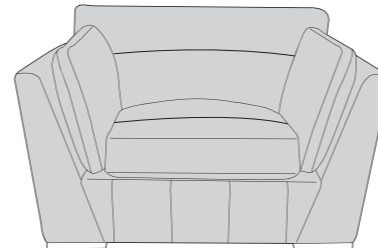

Arm Chair - 1ST-S

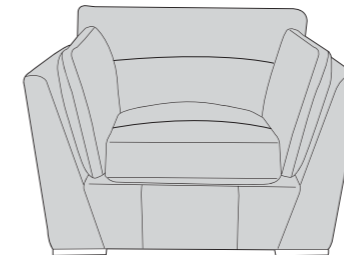

## ACCENT PIECES

Leather Storage Footstool (FSS)

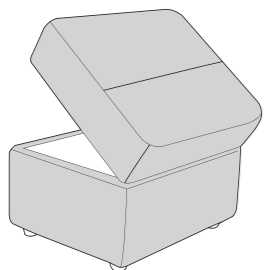



# PHOENIX LEATHER DIMENSIONS (CM)

AVAILABLE PIECES	HEIGHT 1	WIDTH 2	DEPTH 3	SEAT HEIGHT 4	SEAT DEPTH 5	SEAT WIDTH 6	ACCESS DIAGONAL 7	OUTBACK HEIGHT 8	ARM HEIGHT 9	WEIGHT (KG)
LH2, RFC, FST or RH2, LFC, FST CORNER GROUP	87	293	250	54	60	N/A	N/A	69	69	122 (3 Units)
L2S, RFC, FST or R2S, LFC, FST CORNER BED GROUP	87	258	250	54	60	N/A	N/A	69	69	132 (3 Units)
LH2/RH2 UNIT	87	198	95	54	60	160	206	69	69	52
LFC/RFC UNIT	87	176	95	54	60	138	193	69	69	51
L2S/R2S - BED ACTION UNIT	87	163	95	54	60	136	191	69	69	62
LARGE FOOTSTOOL P (FST)	53	74	95	54	60	N/A	112	N/A	N/A	19
<b>SOFA DIMENSIONS</b>										
3 SEATER SOFA (3ST)	87	224	95	54	60	156	237	69	69	62
2 SEATER SOFA (2ST)	87	196	95	54	60	129	211	69	69	58
LOVE CHAIR (LOV)	87	144	95	54	60	79	160	69	69	45.5
ARM CHAIR (1ST)	87	122	95	54	60	54	148	69	69	43
<b>ACCENT PIECES</b>										
STORAGE LEATHER FOOTSTOOL (FSS)	45	63	50	N/A	N/A	N/A	75	N/A	N/A	12.5

## SOFABEDS: SLEEP OPTIONS

**STANDARD ACTION & FOAM MATTRESS**  
A three fold metal action with a sprung 'polyprop' base. Complemented by a high performance foam mattress. For occasional use only.

**Mattress Thickness: 6cm**  
**Mattress Length: 185cm**  
**3 fold action 140Kg total max occupancy weight**



 Full leather, no splits apply.

- \* Hardwood & composite board frame.
- \* Dowelled, screwed, glued & stapled joinery.
- \* Chrome & Wood foot options.

- \* foamflex+ seat interior.
- \* Fibre filled backs for added comfort.
- \* Back cushions secured with zips.

- \* Serpentine seat springs & silent wire.
- \* Elasticated back webbing.

### DIMENSION GUIDE

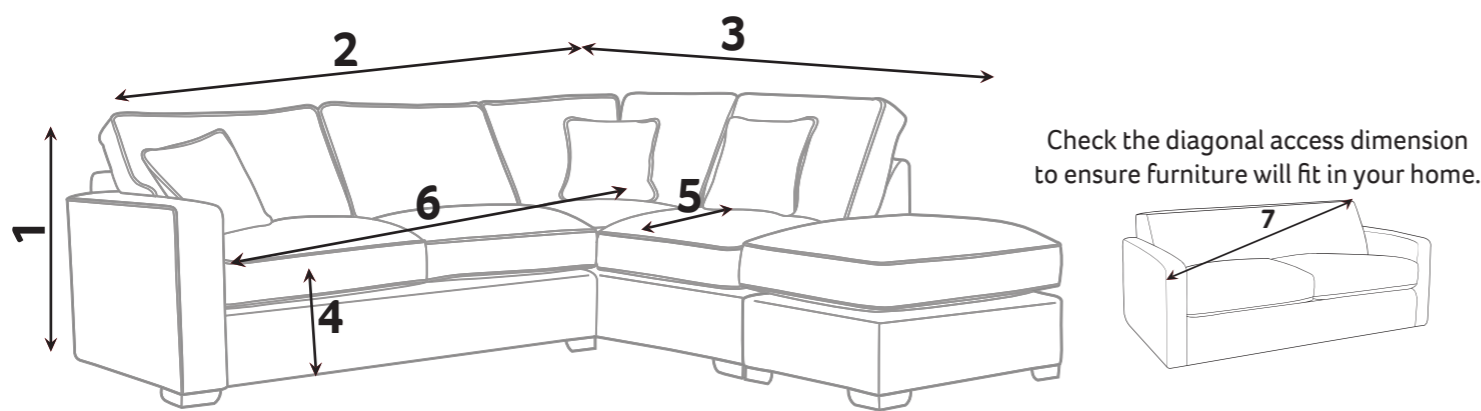

- 1 - HEIGHT
- 2 - WIDTH
- 3 - DEPTH
- 4 - SEAT HEIGHT
- 5 - SEAT DEPTH (STD & PILLOW)
- 6 - SEAT WIDTH
- 7 - DIAGONAL ACCESS

Illustrations used for reference only.

## foamflex+

Our expertly engineered foam seat interior gives you the comfort of fibre with the retention of foam.

### CARE GUIDE

To improve the longevity of your hand-made furniture, we recommend rotating cushions (where applicable).

For further information on maintaining your furniture, please refer to the Care Guide located under the seat platform.

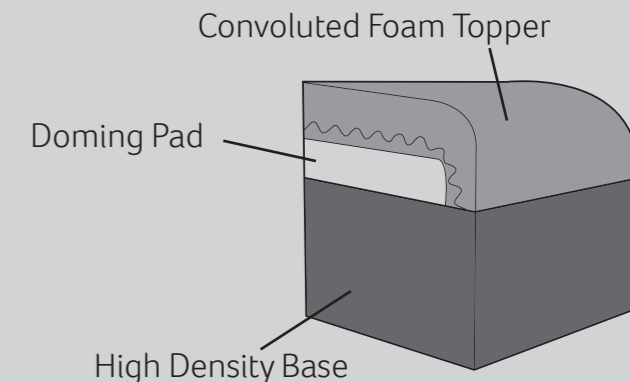

Oak (Light)

Mid Oak

Antique (Dark)

Chrome

FOOT OPTIONS:



See terms & conditions

Please note : All dimensions are approximate. Allow tolerance of +/- 2.5cm.

Wood is a natural product and will vary in shade/colour from item to item.

03/02/2025

# LEATHER RANGE

We only use full leather for our collections; no splits apply.

## PUGLIA

Puglia is a corrected grain leather crafted from top-quality hides processed in Italy. The hides are machine-buffed to remove superficial characteristics, then coated with a pigment to ensure consistent coloration across every piece. The surface is embossed with an artificial grain to deliver a uniform appearance, reducing visible natural markings and enhancing the leather's physical durability. This finish also minimizes absorption from spills, making Puglia a practical and family-friendly option. Available in a refined palette of five versatile colours, Puglia offers an elegant and easy-to-maintain solution for modern living spaces.

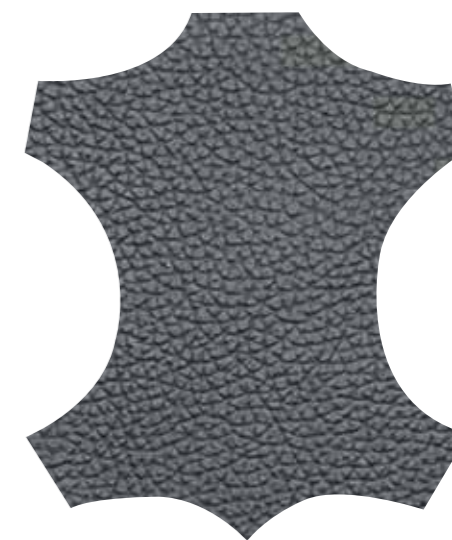

## NAPOLI

Napoli is a natural grain, Semi-Aniline leather made of high quality hides that have been processed in Italy. A special re-tanning process is applied to give the leather its rich hand feel. A contrasting roller effect has been applied to the surface of each hide to add visual character, before being treated with a protective finish to increase durability. A characterful and family-friendly leather.



## LAZIO

Lazio is a hand-buffed Aniline leather made of top quality hides that have been processed in Italy. This leather is a celebration of the rich history of each and every hide and the individual characteristics that make them unique. The hides are buffed by hand, piece by piece. Other than a light protective finish that has been applied to the grain in order to increase its physical performance, Lazio's surface is completely natural and free from additional treatments so as to retain the natural look of the leather. Natural leather will be subject to shade variation between and even within upholstered panels, ensuring every piece of furniture is unique.

